

ADPRO Intrusion Detection

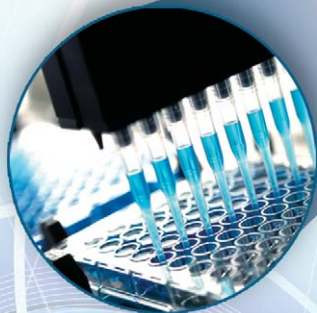

High-performance
Intrinsically Safe
Outdoor Passive
Infrared Detectors
for Hazardous
Environments
in Zone 1 and 2

BAS 11 ATEX 0261X
IECEx BAS 11.0127X
Ex II2G Ex ib IIC T4 Gb
(-20 °C ≤ Ta ≤ +60 °C)



ADPRO[®]
by  **xtralis**[™]

Main Applications

Intrusion detection — an “electronic fence” — in combination with alarm verification — video surveillance — protects property and prevents sabotage.

Hazardous areas, such as fossil fuel and chemical facilities, require high-performance intrusion detection. ADPRO by Xtralis offers defense-grade perimeter protection including ADPRO PRO Outdoor Intrinsically Safe Passive Infrared Detectors.

These systems, which detect temperature differences between moving targets and the stationary background, may be used safely to protect hazardous environments. ADPRO PRO Intrinsically Safe Passive Infrared detectors are ideally suited for use in the following hazardous environments:

Fossil fuel industry

- Oil and gas platforms and refineries
- Petrol, oil, kerosene storage
- Pump stations (railways, harbours, pipelines)

Chemical industry

- Chemical laboratories
- Chemical production sites
- Pyrotechnic material production sites and warehouses

Others

- Electric power transformation substations
- Aircraft hangars and parking facilities for petrol/oil trucks
- Process industry



Technical Concept

Operation of a high-performance, intrinsically safe (IS) ADPRO PRO detector requires the installation of IS barriers for power, switching and communications. The distance from the detector to the non-hazardous area can be up to 200 metres. ADPRO also offers IS barriers for power, switching and communications.

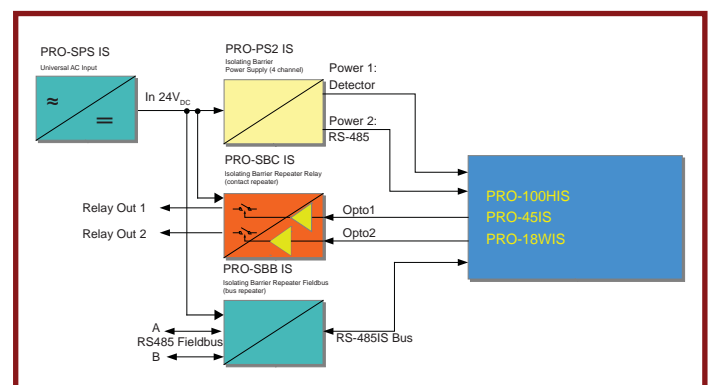

Standards Compliance

The ADPRO intrinsically safe detectors comply to the following standards:

IEC 60079-0 : 2011 Edition: 6.0

Explosive atmospheres - Part 0: General requirements

IEC 60079-11 : 2011-06 Edition: 6.0

Explosive atmospheres - Part 11: Equipment protection by intrinsic safety “i”

IEC 60079-15 : 2010 Edition: 4

Explosive atmospheres - Part 15: Equipment protection by type of protection “n”

ADPRO PRO Outdoor Passive Infrared Detector Reference Chart

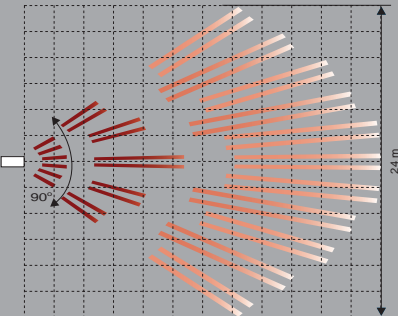
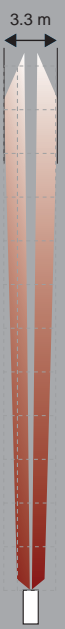
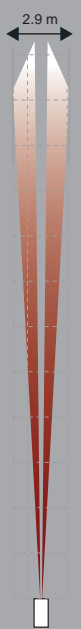
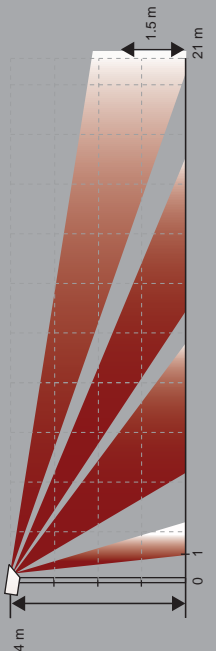
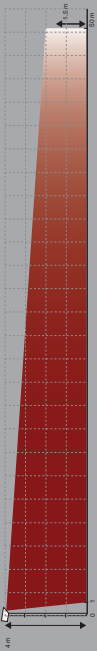
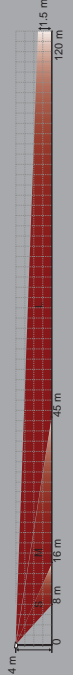
DETECTOR OVERVIEW			
Detection method	Volumetric Wide-Angle	Curtain Medium-Range	Curtain Long-Range
Detector model	PRO-18WIS	PRO-45IS	PRO-100HIS
Item code	CH10051601	CH10021601	CH10030401
Coverage L x W	21 m x 24 m (70 ft x 80 ft)	50 m x 3.3 m (165 ft x 11 ft)	120 m x 2.9 m (394 ft x 9 ft)
Creep zone	1 m (3 ft)	1 m (3 ft)	8 m (26 ft)
Optics	Segmented Precision Mirror	Precision Mirror	
Top View Width at Nominal Range			
Side View			

Technical Data	PRO-18WIS	PRO-45IS	PRO-100HIS
Power supply detector	$U_i = 28 V_{DC}; I_i = 150 \text{ mA}; P_i = 920 \text{ mW}$		Note: power barrier required.
Power supply RS 485	$U_i = 28 V_{DC}; I_i = 150 \text{ mA}; P_i = 920 \text{ mW}$		Note: power barrier required.
Heater Power	n.a		~600mW
Alarm Output	2x Opto-Coupler, $U_i = 28 \text{ VDC}; I_i = 20 \text{ mA}; P_i = 55 \text{ mW}$		Note: switching barrier required.
Data Interface	RS 485, $U_i = \pm 4.2 \text{ VDC}; U_o = 4.2 \text{ VDC}; I_o = 146 \text{ mA}; P_o = 157 \text{ mW}$ according to PNO-Standard;		Note: data barrier required.
Front Window	Silicon Wafer		
Spectral Response	8-14 μm , double filtered		
Operating Temperature	-20 °C to +60 °C (-4 °F to +140 °F)		-40 °C to +60 °C (-40 °F to +140 °F)
Temperature Compens.	Full compensation over entire operating temperature range		
IP-Rating	IP65		
Baseefa ATEX Approval	BAS 11 ATEX 0261X IECEx BAS 11.0127X  II2G Ex ib IIC T4 Gb (-20 °C ≤ Ta ≤ +60 °C)		

► **WARNING!**

ADPRO PRO intrinsically safe PIR detectors are designed to be used with ADPRO IS barriers and must not under any circumstances be installed without ADPRO IS barriers.

Xtralis is the leading global provider of powerful solutions for the early detection of fire and security threats. Our technologies prevent disasters by giving users time to respond before life, critical infrastructure or business continuity is compromised. We protect more than 50,000 customer sites in 100 countries, including billions in assets belonging to the world's top governments and businesses.

Our portfolio of perimeter protection and enterprise security solutions delivers unparalleled situational awareness from your facility's edge to its very core so you can anticipate threats proactively to protect personnel and property.

With ADPRO by Xtralis, you can transform your security program from reactive, forensic monitoring to proactive detection. We offer the industry's broadest range of:

- Defense-grade perimeter protection
- Passive infrared and video motion detection
- Robust video recording and transmission
- Remote monitoring software
- Energy-efficient video storage
- Flexible and scalable IP access control
- Integrated command and control software

www.xtralis.com

UK and Europe +44 1442 242 330 **D-A-CH** +49 431 23284 1 **The Americas** +1 781 740 2223
Middle East +962 6 588 5622 **Asia** +86 21 5240 0077 **Australia and New Zealand** +61 3 9936 7000

The contents of this document are provided on an "as is" basis. No representation or warranty (either express or implied) is made as to the completeness, accuracy or reliability of the contents of this document. The manufacturer reserves the right to change designs or specifications without obligation and without further notice. Except as otherwise provided, all warranties, express or implied, including without limitation any implied warranties of merchantability and fitness for a particular purpose are expressly excluded.

This document includes registered and unregistered trademarks. All trademarks displayed are the trademarks of their respective owners. Your use of this document does not constitute or create a licence or any other right to use the name and/or trademark and/or label.

This document is subject to copyright owned by Xtralis AG ("Xtralis"). You agree not to copy, communicate to the public, adapt, distribute, transfer, sell, modify or publish any contents of this document without the express prior written consent of Xtralis.

Document: 18847_08

ADPRO[®]
 by  **xtralis**[™]